



# HEXAGON WORLD



EQUIPAGGIAMENTO  
PER TRASPORTO

CATALOGO

# INDICE

## **RACCORDERIA**

Pag 06

CAMLOCK  
GUILLEMIN  
TEDESCA DIN 28450  
STORZ  
VELOX  
EXPRESS  
ECO (FERRARI)  
GAS  
DIN  
GAROLLA  
TRICLAMP  
TANK UNIT  
ACCOPIATORI API  
ITALIANA (BAIONETTA)  
PVC PESANTE - 81Q  
INOX PESANTE  
CUSTOM

## **BOCCAPORTI**

Pag 24

BOCCA DI LAVAGGIO DN300  
PASSO D'UOMO DN500

## **VALVOLE DI SICUREZZA**

Pag 26

### **VALVOLA DI DEPRESSIONE YAK**

Pag 28

### **VALVOLA DI SICUREZZA**

Pag 28

### **VALVOLA DI RITEGNO**

Pag 28

## **VALVOLE DI FONDO**

Pag 29

INOX  
EBANITATA  
NEATCO  
NEATCO 90° BITUMEN  
CHEMFLOW 90°

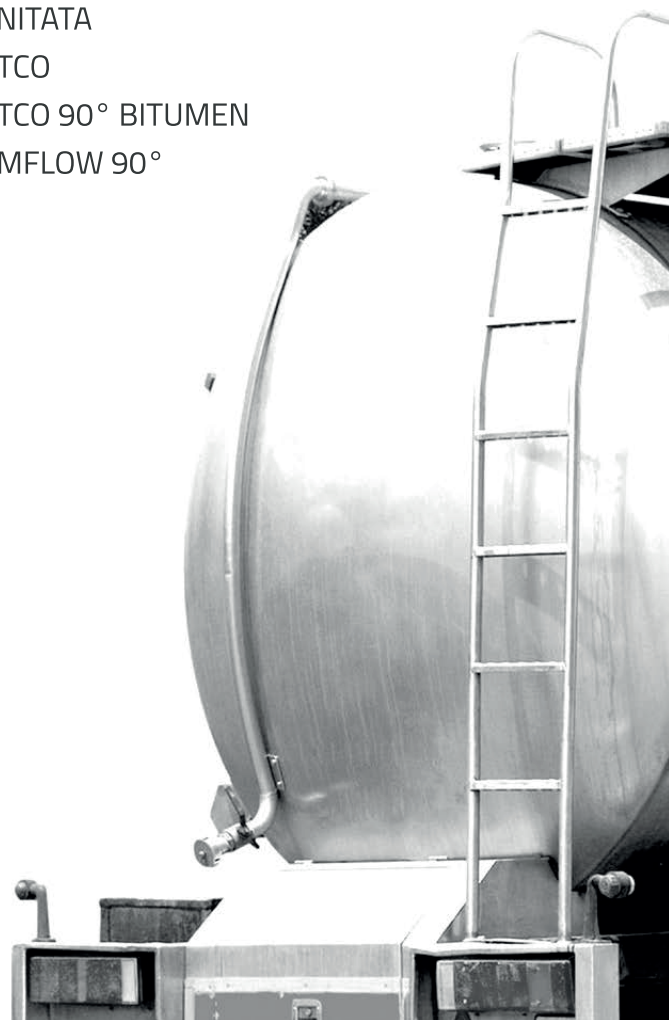

**VALVOLA A FARFALLA TANKFLY** **Pag 34**

---

**VALVOLA A FARFALLA FK** **Pag 35**

---

**VALVOLA A FARFALLA IN METALLO** **Pag 36**

---

**VALVOLE AKO** **Pag 36**

---

**VALVOLA A SFERA AIRLINE** **Pag 37**

---

**VALVOLE A SFERA** **Pag 38**

---

**SEMIGUSCI** **Pag 40**

---

**BOCCOLE** **Pag 40**

---

**ACCESSORI** **Pag 41**

---

**TUBI** **Pag 42**

---

IN GOMMA  
IN PVC  
TRECCIATI INOX  
COMPOSITI

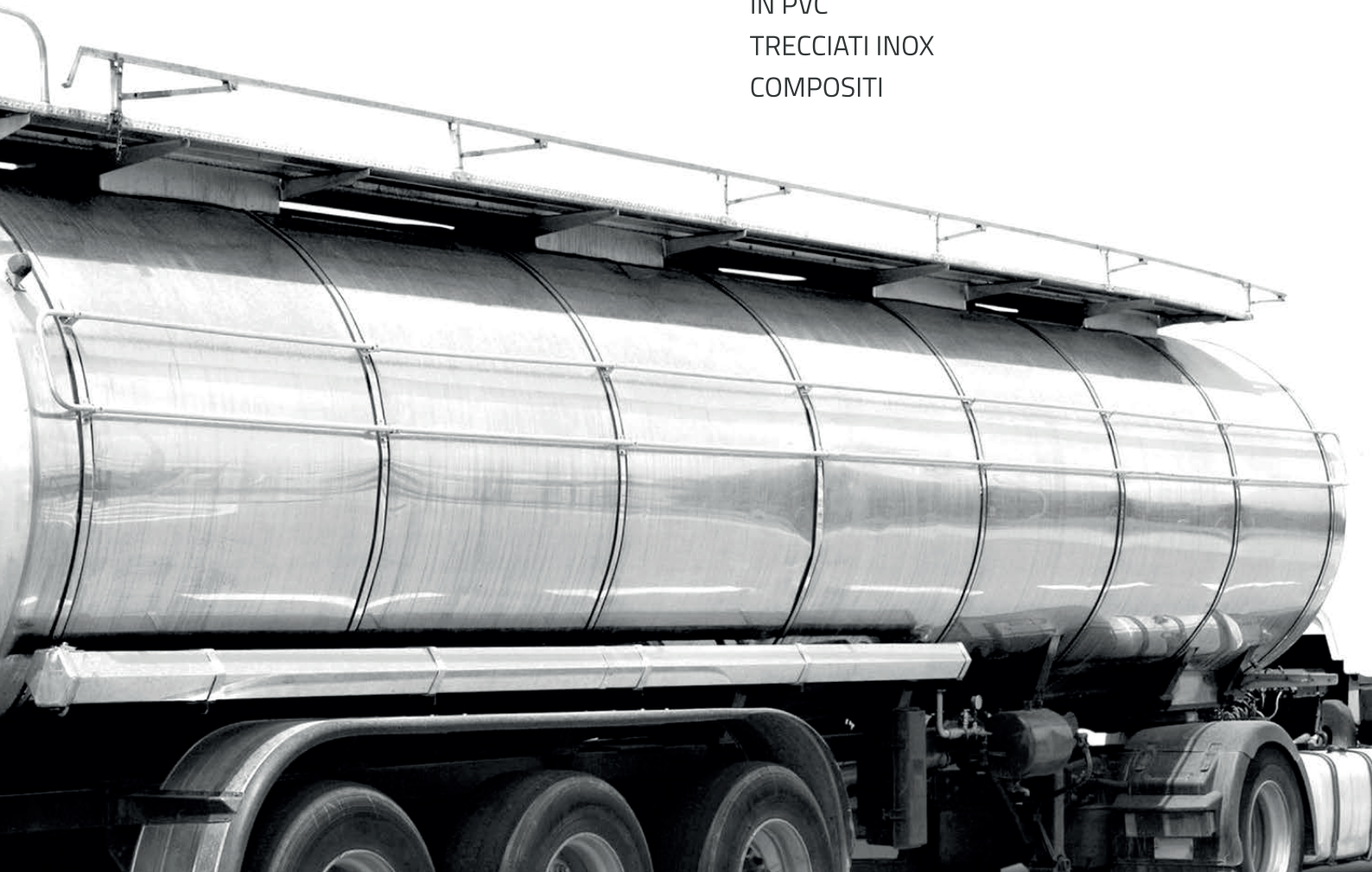

# RACCORDERIA CAMLOCK



**Tipo A**  
Raccordo femmina  
filettato FED MIL



**Tipo B\***  
Raccordo maschio filettato  
EN 14420-7/ FED MIL



**Tipo C**  
Raccordo con portagomma  
serrato FED MIL

\*disponibile anche a saldare

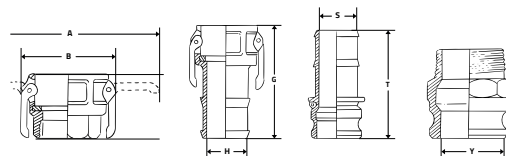

**Tipo D**  
Raccordo femmina  
filettato FED MIL



**Tipo E**  
Raccordo con portagomma  
serrato FED MIL



**Tipo F\***  
Raccordo maschio  
filettato FED MIL/EN  
14420-7

DN	Pollici	A	B	G	H	S	T	Y
13	1/2"	75	40	66	10	10	62	14
20	3/4"	115	50	85	14	14	76	19
25	1"	138	62	98	20	19	92	23
32	1.1/4"	178	81	104	26	25	98	28
40	1.1/2"	185	87	109	32	31	102	36
50	2"	195	90	124	43	43	117	46
65	2.1/2"	208	111	135	54	56	129	56
80	3"	250	143	159	66	64	153	73
100	4"	270	171	169	89	89	168	98
125	5"	300	-	188	118	118	188	118
150	6"	400	254	240	140	138	230	150



**Tipo DC**  
Tappo di protezione  
femmina FED MIL/EN  
14420-7



**Tipo DP**  
Tappo di protezione  
maschio FED MIL/EN  
14420-7

## GUARNIZIONI CAMLOCK



Disponibili nei seguenti materiali

NBR, EPDM, FPM, CSM,  
PTFE/EPDM, PTFE/FPM, PTFE

DN	Pollici	DIMENSIONI		
		Ø EST. +/- 0,3 mm	Ø INT. +/- 0,2 mm	SP. +/- 0,2 mm
15	1/2"	26,5	17,5	4,0
20	3/4"	35	22	5,5
25	1"	40	27	6,4
32	1.1/4"	50	35	6,4
40	1.1/2"	56	41	6,4
50	2"	67	51	6,4

DN	Pollici	DIMENSIONI		
		Ø EST. +/- 0,3 mm	Ø INT. +/- 0,2 mm	SP. +/- 0,2 mm
65	2.1/2"	80	60	6,4
80	3"	95	76	6,4
100	4"	124	102	6,4
125	5"	150,5	124	6,4
150	6"	180	153	6,4
200	8"	232,5	203,5	7,9

## RACCORDI FLANGIATI



**Tipo AF**



**Tipo DF**

## ACCESSORI



**Rivestimenti per utilizzo con prodotti chimici altamente corrosivi**

PFA & PTFE  
PTFE nero elettrostatico  
Verniciatura a polvere (7 RAL)  
PVDF, ECTFE (Halar)

### Normative

FED MIL A-A-59326A  
EN 14420-7  
DIN 2828

### Materiali

AISI316, Ottone, Bronzo, Alluminio,  
PP, Rivestimenti per prodotti chimici  
altamente corrosivi in PVDF, PTFE,  
ECTFE, PFA

### Filettature

GAS/BSP, NPT

### Su richiesta

Raccordi flangiati  
e accessori

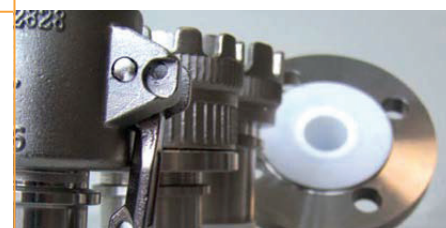

# RACCORDERIA GUILLEMIN



Raccordo maschio filettato senza anello di chiusura



Raccordo maschio filettato con anello di chiusura



Raccordo femmina filettato senza anello di chiusura



Aggancio femmina filettato con anello di chiusura



Raccordo con testa a saldare senza anello di chiusura



Raccordo con testa a saldare con anello di chiusura



Raccordo portagomma con anello di chiusura



Portagomma con anello di chiusura senza alette



Riduzione Guillemín - Guillemín



Tappo con anello di chiusura



Tappo con maniglia



Tappo senza anello di chiusura

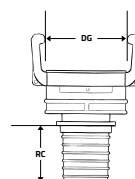

DG	DN
55	40
69	50
84	65
103	80
123	100

## Raccordo RC Filettato disponibile nelle misure

Pollici	1"1/2	2"	2 1/2"	3"	4"
---------	-------	----	--------	----	----

## Raccordo RC a Saldare disponibile nelle misure

mm	48,26x3,68	60,33x3,91	73,03x5,16	88,90x5,49	114,30x6,02
----	------------	------------	------------	------------	-------------

## Raccordo RC Portagomma disponibile nelle misure

mm	38	50-55	65	75-80	100
----	----	-------	----	-------	-----

## GUARNIZIONI GUILLEMIN



### Disponibili nei seguenti materiali

NBR - nero, EPDM - bianco, FPM - verde, PTFE - bianco

DN	Pollici	Ø EST. mm	Ø INT. mm	SP. mm
25	1"	34,3	27,3	4
32	1.1/4"	38	32	4,5
40	1.1/2"	51	43	5
50	2"	64	54	5
65	2.1/2"	79	69	6
80	3"	96	85	6
100	4"	117,5	103,5	7

## ACCESSORI



Catenella



Chiavi universali

### Rivestimenti per utilizzo con prodotti chimici altamente corrosivi

PFA & PTFE  
PTFE nero elettrostatico  
Verniciatura a polvere (7 RAL)  
PVDF, ECTFE (Halar)

### Normative

EN 14420-8  
NF E 29-572

### Materiali

AISI316, Alluminio, Polipropilene

### Pressione di esercizio

16 BAR

### Temperatura

-20°C / + 65°C



# RACCORDERIA TEDESCA DIN 28450



**A** Raccordo femmina MK con filetto femmina e leva di chiusura e guarnizione



**B** Raccordo maschio VK con filetto femmina e guarnizione

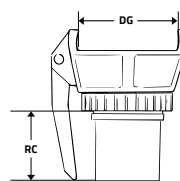

DN	DG femmina MK
50	70
80	96
100	132



Tappo femmina MB



Tappo di protezione VB

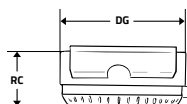

DN	DG maschio VK
50	77
80	110
100	141



Raccordo femmina MK con leva di chiusura e portagomma liscio e anello antisfilamento



Raccordo maschio VK con portagomma liscio e anello antisfilamento

Raccordo RC Filettato			
DN	50	80	100
Pollici	2"	3"	4"

Raccordo RC Portagomma			
DN	50	80	100
mm	40	75	100

## ACCESSORI



Catena con Gancio

## GUARNIZIONI CAMLOCK



### Disponibili nei seguenti materiali

NBR - nero, PU - marrone, CSM - verde, PTFE - bianco, FPM - nero

DIMENSIONI				
DN	Pollici	Ø EST. +/- 0,2 mm	Ø INT. +/- 0,3 mm	SP. +/- 0,2 mm
50	2"	62,5	49	10
80	3"	92	76	11,6
100	4"	113	99	7

### Rivestimenti per utilizzo con prodotti chimici altamente corrosivi

PFA & PTFE  
PTFE nero elettrostatico  
Verniciatura a polvere (7 RAL)  
PVDF, ECTFE (Halar)

### Materiali

AISI 316 / 1.4408, Alluminio da forgatura, Ottone, Rivestiti (solo **A** e **B**)





# RACCORDERIA STORZ



Raccordo con portagomma



Raccordo con portagomma e dente antisfilamento



Raccordo con filetto femmina

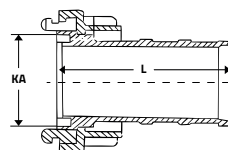

Dimensione	KA
25	31
32	44
38	52
52-C	66
65	81
75-B	89
100	115
110-A	133
150	160



Raccordo con filetto maschio



Raccordo con testa femmina filettata girevole



Riduzioni storz-storz



Tappo vuoto con catenella

Raccordo RC Filettato disponibile nelle misure					
Pollici	1/2"	3/4"	1"	1"1/4	1"1/2
	1"3/4	2"	2"1/2	3"	4"
	4"1/2	5"	6"	8"	10"

Raccordo RC Portagomma disponibile nelle misure					
Pollici	15	19	25	32	38
	40	42	45	50	52
	55	60	63	65	70
	75	80	90	100	110
	125	150	205	258	

## CHIAVE PER RACCORDI STORZ



Chiave tipo A-B-C  
Manico rivestito in plastica

## GUARNIZIONI



### Disponibili nei seguenti materiali

NBR - nero/bianco, VITON (Inox), Silicone

### Materiali

Alluminio  
Acciaio AISI 316 / 1.4408



# RACCORDERIA VELOX



Raccordo maschio filettato



Raccordo femmina filettato

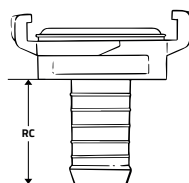

Raccordo con portagomma



Tappo

Raccordo RC Filettato										
disponibile nelle misure										
Pollici	3/8"	-	1/2"	-	-	3/4"	1"	1"1/4"	-	1"1/2"

Raccordo RC Portagomma										
disponibile nelle misure										
mm	10	13	-	16	19	-	25	32	38	40

## GUARNIZIONI



DIMENSIONI		
Ø EST. mm	Ø INT. mm	SP. +0,5 mm
35	24	12

### Disponibili nei seguenti materiali

NBR - nero, FPM - verde

### Materiali

Ottone 2,0401 - Ms 58 forgiato caldo





# RACCORDERIA EXPRESS **HEXAGON** WORLD



Raccordo maschio filettato



Raccordo femmina filettato

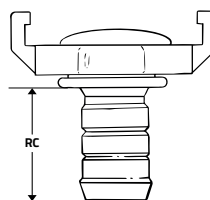

Raccordo con portagomma serrato



Tappo

Raccordo RC Filettato									
disponibile nelle misure									
Pollici	1/4"	3/8"	1/2"	-	1/2"	-	3/4"	1"	1 1/4"

Raccordo RC Portagomma									
disponibile nelle misure									
mm	6	10	13	-	16	20	25	-	-



Morsetto

## GUARNIZIONI



DIMENSIONI		
Ø EST. mm	Ø INT. mm	SP. +0,5 mm
35	15	10

Disponibili nei seguenti materiali

NBR - nero, FPM - verde

### Materiali

AISI 316 / 1.4408 , Ottone

# RACCORDERIA ECO (FERRARI)



Sfera in Inox



Anello in Inox



Tappo femmina in  
Inox con catenella



Tappo maschio in Inox  
con catenella

Raccordo sferico  
completo in Inox



Controsfera Inox  
con tronchetto  
portagomma



Sfera e anello Inox  
con tronchetto  
portagomma



Controsfera in Inox

DIMENSIONE RACCORDI	
DN	
	50
	60
	80
	100
	120
	150

## GUARNIZIONI



**Disponibili nei seguenti materiali**  
NBR - nero/bianco, VITON

## DISPONIBILI SU RICHIESTA



**Giunti ANFOR  
fino a 400mm  
(16")**



**Giunti  
Perrot**

### Disponibili su richiesta

Altri raccordi e accessori per  
irrigazione, carribotte e pompaggio,  
a saldare - filettati - con  
portagomma

### Materiali

Acciaio AISI 316 / 1.4408 / Ferro Zincato



# RACCORDERIA GAS



Raccordo portagomma liscio GAS maschio



Raccordo portagomma con resche GAS maschio

Raccordo Filettato					
disponibile nelle misure					
Pollici	1/2"	3/4"	1"	1"1/4	1"1/2
	2"	2"1/2	3"	4"	cassone



Raccordo portagomma liscio GAS femmina



Raccordo portagomma con resche GAS femmina

Raccordo Portagomma					
disponibile nelle misure					
mm	20	25	30	40	50
	60	65	70	75	80
	90	100			



Tappo filetto femmina



Tappo filettato maschio Alluminio/Ottone

## RACCORDI FLANGIATI



Raccordo a flangia girevole con portagomma

## RACCORDI PER VAPORE



Raccordo tubo vapore Maschio

Materiale: Ottone  
Normativa: EN14423



Semiguscio per vapore

Materiale: Ottone  
Normativa: EN14423

**Normative**  
EN14420-2

**Materiali**  
AISI316, Ottone

**Pressione esercizio:**  
25 bar



# RACCORDERIA DIN

## TAPPI



Portagomma con maschio DIN Inox



Portagomma con femmina DIN Inox



Tappo DIN femmina



Tappo PE filetto DIN femmina

DN	Tenuta 1	Tenuta 2
65	NBR blu	silicone
80	NBR blu	silicone
100	NBR blu	silicone



Maschio a saldare Inox



Femmina a saldare Inox



Girella cieca



Tappo PE filetto DIN maschio

DN	Tenuta 1	Tenuta 2
65	NBR blu	silicone
80	NBR blu	silicone
100	NBR blu	silicone



Girella DIN Inox

## GUARNIZIONI PER GIRELLA CIECA



Disponibili nei seguenti materiali  
NBR

DIMENSIONI				
DN	Pollici	Ø EST	Ø INT	SP
15	1/2"	26,0	18,0	4,5
20	3/4"	33,0	23,0	4,5
25	1"	40,0	30,0	5,0
32	1.1/4"	46,0	36,0	5,0
40	1.1/2"	52,0	42,0	5,0
50	2"	64,0	54,0	5,0

DIMENSIONI				
DN	Pollici	Ø EST. +/- 0,3 mm	Ø INT. +/- 0,2 mm	SP. +/- 0,2 mm
65	2.1/2"	81,0	71,0	5,0
-	3"	88,0	78,0	5,0
80	3"	95,0	95,0	5,0
100	4"	114,0	104,0	6,0

## ACCESSORI



Catenella



Chiave per Raccordi DIN

### Rivestimenti per utilizzo con prodotti chimici altamente corrosivi

PFA & PTFE  
PTFE nero elettrostatico  
Verniciatura a polvere (7 RAL)  
PVDF, ECTFE (Halar)

### Materiali

AISI 304, AISI 316





# RACCORDERIA GAROLLA **HEXAGON** WORLD



Semiraccordo  
garolla - tronchetto  
GAS



Semiraccordo  
garolla con  
portagomma



Semiraccordo  
garolla

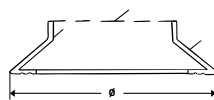

DN	Ø	DN	Ø
40	67	80	108
50	78	100	127
60	88	120	158
70	98	150	188



Morsetto garolla



Tappo garolla

## GUARNIZIONI

Disponibili nei seguenti  
materiali

NBR, Silicone



**Materiali** AISI 304

# RACCORDERIA TRICLAMP



Portagomma



Semiraccordo

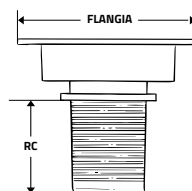

Pollici Flangia	Pollici Flangia
1/2"	2"
3/4"	2 1/2"
1"	3"
1 1/2"	4"



Morsetto



Tappo

Raccordo RC Portagomma					
DN					
mm	12	20	25	32	38
	50	60	63	75	100

## GUARNIZIONI

Disponibili nei  
seguenti materiali  
NBR, EPDM, FPM, PTFE



Non-profiled

Pollici	Pollici
1/2"	2"
3/4"	2 1/2"
1"	3"
1 1/2"	4"

## Normative

DIN 32676

INCH

BRITISH STANDARD

ISO 1127

## Applicazioni

Per applicazioni nel settore alimentare, delle bevande, chimico, farmaceutico, nonché bioingegneria, filtri e trattamento acque

## Materiali

AISI 316, Polipropilene o PTFE rinforzato (su richiesta)



# TANK UNIT



**Raccordo Maschio:** 2" - 3"  
**Materiali:** Inox, Ottone, Alluminio



**Raccordo Maschio flangiato:** 3"  
**Materiali:** Inox



**Raccordo Femmina:** 2" - 3"  
**Materiali:** Inox, Ottone



**TAPPO**  
**Materiali:** Gomma, Alluminio, Materiale composito

# ACCOPPIATORI API



**ACCOPPIATORE API MASCHIO**

**Materiale:** Alluminio, Ottone

**Flangia:** 4" TTMA

**Guarnizione:** Viton®

**Passaggio:** 2500 l/min

**Pressione di esercizio:** 5 bar

**ACCOPPIATORE API FEMMINA**

**Materiale:** Alluminio, Ottone

**Flangia:** 4" TTMA

**Guarnizione:** Viton®

**Passaggio:** 150 m3/h

**Pressione di esercizio:** 6 bar

**ACCOPPIATORE API MASCHIO CON LEVA**

**Materiale:** Alluminio, Acciaio

**Flangia:** 4" TTMA

**Guarnizione:** O-ring Viton®

**Passaggio:** 2500 l/min

**Pressione di esercizio:** 5 bar

**FLANGE, GUARNIZIONI, TAPPI**

**Flangia:**  
Inox - 4" Passo-Cassone F

**Guarnizione:** NBR

# RACCORDERIA ITALIANA (BAIONETTA)



Raccordo portagomma attacco rapido M



Raccordo portagomma attacco rapido F



Riduzione attacco rapido F filetto GAS F

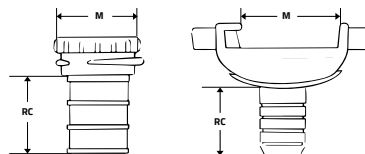

Disponibile nelle misure

Pollici	2"	3"	4"
---------	----	----	----



Riduzione attacco rapido F filetto GAS M



Riduzione attacco rapido M filetto M



Riduzione attacco rapido F/M

Disponibile nelle misure

mm	40	50	60	65	100
----	----	----	----	----	-----

## Materiali

Alluminio da forgiatura, Ottone



Ghiera ad attacco rapido M filetto GAS F



Tappo rapido 3" Alluminio M



Tappo rapido 3" Alluminio F



## GUARNIZIONI

Disponibili nei seguenti materiali

NBR, VITON

# RACCORDERIA PVC PESANTE - 81Q

## PORTAGOMMA



Portagomma PVC pesante con dentino antisfilamento per girella 81Q



Portagomma PP pesante con dentino antisfilamento per girella 81Q



Portagomma PVC pesante con dentino antisfilamento x 81Q maschio

Ø portagomma

60

80



Cartella incollo PVC pesante per Girella 81Q

Ø 63mm M INCOLLO



Cartella PVC pesante per Girella 81Q filettato

2" GAS M

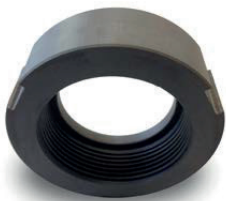

Girella pvc 81Q

Ø Interno

81



Adattatore PVC pesante 81Q maschio

Ø Interno incollaggio

63





Tappo PVC 81Q femmina  
con nottolino per catenella



Flangia PVC con filetto  
81Q maschio

Ø Est. Flangia	Ø Interasse Flangia	N° Fori
200	160	4

## RIDUZIONI PVC PESANTE



4" CASSONE F X81Q M  
81QF X2" - 1/2 GAS M  
81QF X4" - CASSONE M

## ACCESSORI



Chiave Universale Inox

## RICAMBI



O-Ring EPDM 6287  
per raccordi 81Q

Realizzabili con altri materiali su richiesta del cliente

# RACCORDERIA INOX PESANTE



Portagomma Inox  
Pesante per Girella



Portagomma Inox  
pesante GAS M  
(diam. 80 con dentino  
antisfilamento)

DN	Girella
Ø mm	Pollici
50	2" GAS
	2"1/2 GAS
60	2"1/2 GAS
	3" GAS
80	3" GAS
	4" CASSONE
	4" GAS
100	4" CASSONE
	4" GAS



Girella Inox



Cartella Inox Pesante  
a saldare per Girella



Nipplo doppio Inox  
Pesante con nottolini

Filetto Maschio
2"1/2 GAS
3" GAS
4" GAS
4" CASSONE



Nipplo ridotto Inox  
Pesante con nottolini

Filetto M	Filetto M
2" GAS	2"1/2 GAS
2"1/2 GAS	3" GAS
3" GAS	4" CASSONE
3" GAS	4" GAS
4" CASSONE	4" GAS

## ACCESSORI



Catena con Gancio

## RICAMBI

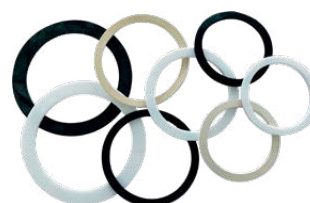

Guarnizioni per Girella Inox

dimensioni
2"
2"1/2
3"
4"

**Disponibili nei seguenti materiali**  
EPDM - bianco, EPDM - nero, PTFE



Riduzione Inox pesante  
passo cassone F - gas M  
con guarnizione

Riduzione Femmina	Riduzione Maschio
2" GAS	2"1/2 GAS
2" GAS	3" GAS
2"1/2 GAS	3" GAS
3" GAS	2" GAS
3" GAS	2"1/2 GAS
3" GAS	4" CASSONE
4" CASSONE	2"1/2 GAS
4" CASSONE	3" GAS



Tappo forato Inox Pesante  
GAS F con foro passante



Tappo Inox Pesante GAS F  
(anche con guarnizione PTFE)

Filetto Femmina
2" GAS
2"1/2 GAS
3" GAS
4" GAS
4" CASSONE



Tronchetto Inox  
Pesante filettato

Filetto Maschio
2" GAS
2.1/2" GAS
3" GAS
4" GAS
4" CASSONE

## TRONCHETTO FISSO



**Materiali:**  
Ferro zincato,  
Inox, Aisi 304

**Ø tubo:**  
75 - 100

## GUARNIZIONE PER FLANGIA TRONCHETTO SP.8



**Materiali:**  
Gomma Nera,  
Gomma Bianca

**Ø Esterno:** 190  
**Ø interasse fori:** 160  
**n. fori:** 2

# RACCORDERIA CUSTOM

Forniamo qualunque tipo di combinazione  
tra le principali famiglie di raccordi

CAMLOCK

GUILLEMIN

TEDESCA DIN 28450

STORZ

ECO (FERRARI)

GAS

DIN

GAROLLA

TRICLAMP

ITALIANA (BAIONETTA)

INOX PESANTE



Combinazioni di raccordi in materiale  
plastico su richiesta del cliente



## ALTRI ESEMPI DI COMBINAZIONI





**HEXAGON**  
WORLD

# BOCCA DI LAVAGGIO DN300

## Caratteristiche

4 TIRANTI

Con e senza anello di compensazione

Disponibile  
anche in versione  
**EBANITATA**



## RICAMBI

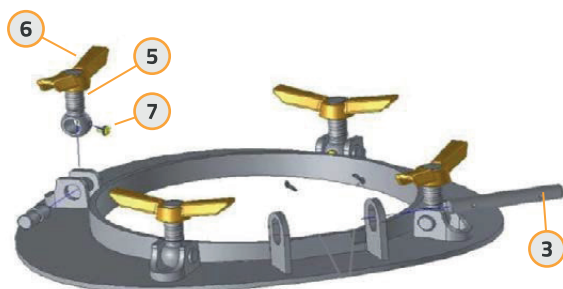

PEZZI DI RICAMBIO	
N°	Descrizione
3	Kit per cerniera
5-6-7	Tirante completo versioni INOX - INOX + BRONZO

## ACCESSORI



**GUARNIZIONI STAMPATE IN**  
EPDM - SILICONE - VITON - NBR - EPDM + PTFE



**BADERNE**  
SYNETIC PTFE  
VETRO + PTFE - PTFE

SEZIONI		
10x10	12x10	14x14
15x10	15x12	15x15
20x20		

**FORMATI**  
Rocchetto - L1660 per  
Bocca di Lavaggio DN300



**GUARNIZIONI IMBUSTATE**  
DN 300, PTFE + EPDM

**Misure**  
15x10, 15x12, 14x14

# PASSO D'UOMO DN500

## Caratteristiche

4-6-8 TIRANTI

Con e senza anello di compensazione



Disponibile  
anche in versione  
**EBANITATA**



Disponibile  
anche in versione  
**DN450 SPECIFICO  
PER POLVERI**



## RICAMBI

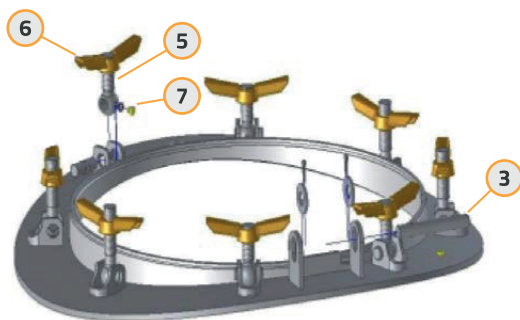

PEZZI DI RICAMBIO	
N°	Descrizione
3	Kit per cerniera
5-6-7	Tirante completo versioni INOX - INOX + BRONZO

## ACCESSORI



**GUARNIZIONI STAMPATE IN**  
EPDM - SILICONE - VITON - NBR - EPDM + PTFE



**BADERNE**  
SYNTETIC PTFE  
VETRO + PTFE - PTFE

SEZIONI		
10x10	12x10	14x14
15x10	15x12	15x15
20x20		

**FORMATI**  
Rocchetto - L1660 per  
Bocca di Lavaggio DN300



**GUARNIZIONI IMBUSTATE**  
DN 500, PTFE + EPDM

**Misure**  
15x10, 15x12, 14x14



**HEXAGON**  
WORLD

# VALVOLE DI SICUREZZA

## MEGASUPERVENTIX FLANGIATA E FILETTATA

### Caratteristiche

2" 1/2 - 3"

TARATURE A RICHIESTA



### Caratteristiche

2" 1/2

TARATURE A RICHIESTA



## RICAMBI

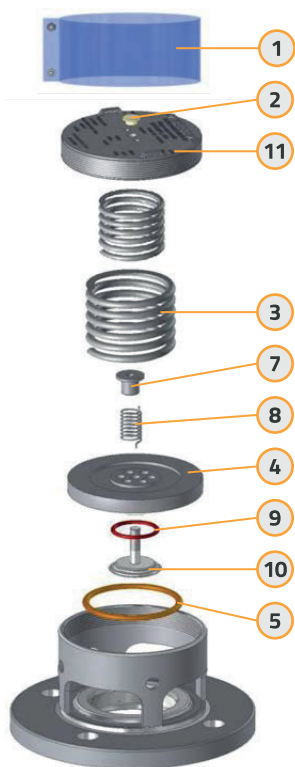

PEZZI DI RICAMBIO	
N°	Descrizione
1	Kit copertura antifiamma
2	Tappo
11	Coperchio chiusura
3	Molla di regolazione pressione
4	Otturatore
5	O'Ring di pressione
9	O'Ring depressione
7	Dado di regolazione
8	Molla di regolazione vuoto
10	Otturatore vuoto
7-8-9-10	Kit per vuoto

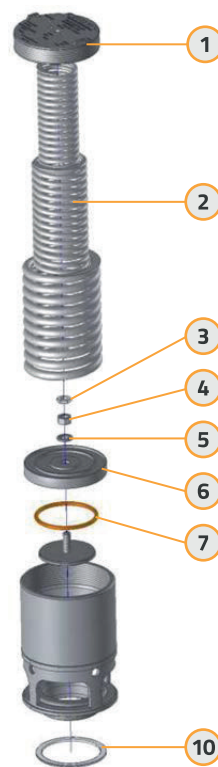

PEZZI DI RICAMBIO	
N°	Descrizione
1	Coperchio chiusura
2	Molla di regolazione pressione
3-4-5-6	Kit otturatore pressione
7	O'Ring
10	Guarnizione filetto



## DISPONIBILE ANCHE IN VERSIONE **HALAR**

"Extreme Resistance to Corrosion"

### Materiali Otturatore

Pressure Plate: Hastelloy C276 - Vacuum Plate: Hastelloy C276

Pressure Plate: Titanium - Vacuum Plate: PVDF

Pressure Plate: PVDF - Vacuum Plate: PVDF

### Caratteristiche

2" 1/2

PRESSIONE E DEPRESSIONE



## ACCESSORI



MANOMETRO  
D.63 GLICERINA



DISCO DI ROTTURA

### TARATURE A RICHIESTA

1"1/2	2"	2"1/2	3"
-------	----	-------	----



GUARNIZIONI  
IMBUSTATE  
PTFE

### Accessori Halar

FLANGIA A SALDARE

GUARNIZIONE



HEXAGON  
WORLD

# VALVOLA DI DEPRESSIONE YAK

## Caratteristiche

1" 1/4 - 1" 1/2 - 2"

TARATURE A RICHIESTA



# VALVOLA DI SICUREZZA

## Caratteristiche

1/2" - 3/4"

OTTONE

TARATURE A RICHIESTA



# VALVOLA DI RITEGNO

## Caratteristiche

1"1/2 - 2" - 2"1/2 - 3" - 4"

OTTONE

INOX

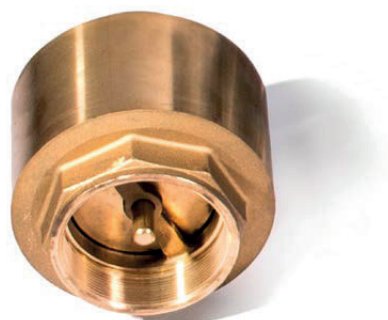



# VALVOLA DI FONDO INOX

## Caratteristiche

DN 100

DN 150



## RICAMBI



GUIDE OTTURATORE



PRIGIONIERI DI SICUREZZA

## ACCESSORI



GUARNIZIONE  
PRIMARIA  
OTTURATORE  
VALVOLA DI  
FONDO



CONTROFLANGIA



GUARNIZIONE  
VALVOLA DI  
FONDO



GUARNIZIONE  
IMBUSTATA PTFE

# COMANDO VALVOLA DI FONDO INOX



## RICAMBI



VOLANTINO INOX



GUARNIZIONI COMANDO  
VALVOLA DI FONDO

## ACCESSORI



BOCCOLA INOX  
PER ALBERO



GUARNIZIONE  
IMBUSTATA PTFE



**HEXAGON  
WORLD**

# VALVOLA DI FONDO EBANITATA

## Caratteristiche

DN80



## RICAMBI



GUARNIZIONE  
PRIMARIA OTTURATORE



OTTURATORE PVC VALVOLA  
DI FONDO

## ACCESSORI



GUARNIZIONI  
IMBUSTATE  
OTTO FORI

# COMANDO VALVOLA DI FONDO EBANITATA

## Caratteristiche

DN80



## RICAMBI



VOLANTINO DI  
RICAMBIO



DADO PVC  
PREMISTOPPA



PERNO FILETTATO  
SINISTRO INOX



GUARNIZIONE  
PREMISTOPPA



BOCCOLA INOX PER  
VOLANTINO



FLANGIA PVC  
COMANDO



# VALVOLA DI FONDO NEATCO

## Caratteristiche

DN 80

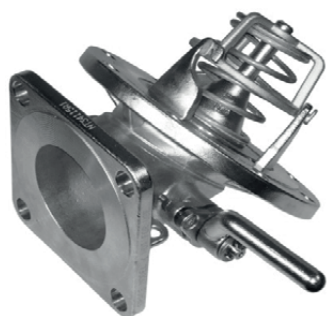

## ACCESSORI



GUARNIZIONE IMBUSTATA  
OTTO FORI



GUARNIZIONE IMBUSTATA  
QUATTRO FORI

## RICAMBI

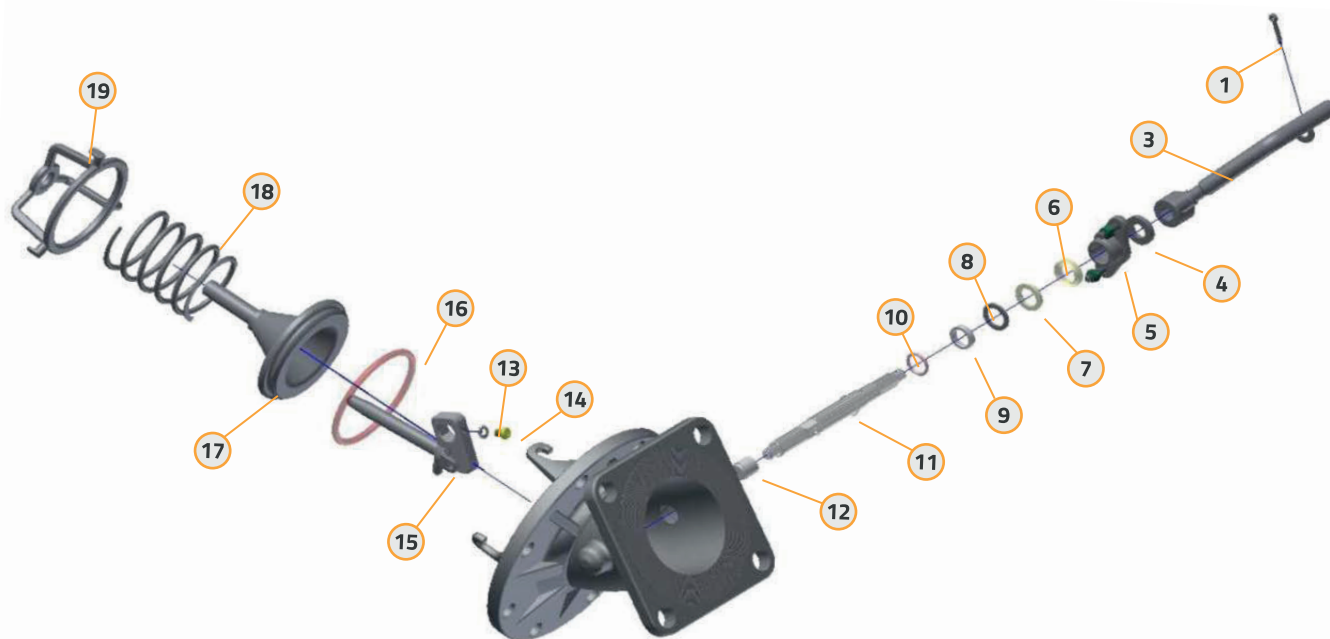

PEZZI DI RICAMBIO	
11	Kit copertura antifiamma

KIT GUARNIZIONE PERNO	
12	Boccola
10	O'Ring
9	Boccola perno
7	Anello di tenuta
6	Premistoppa
4	Distanziatore
2	Rondella
1	Coppiglia

KIT ASTA OTTURATORE	
15	Perno spinta
14	Vite M6-8
13	Rondella M6
19	Castello
18	Molla
16	OR Otturatore
17	Otturatore

KIT MANIGLIA	
3	Maniglia
1	Coppiglia
2	Rondella



# VALVOLA DI FONDO NEATCO 90° BITUMEN

## Caratteristiche

4"



## ACCESSORI



GUARNIZIONE IMBUSTATA  
OTTO FORI



GUARNIZIONE IMBUSTATA  
QUATTRO FORI

## RICAMBI

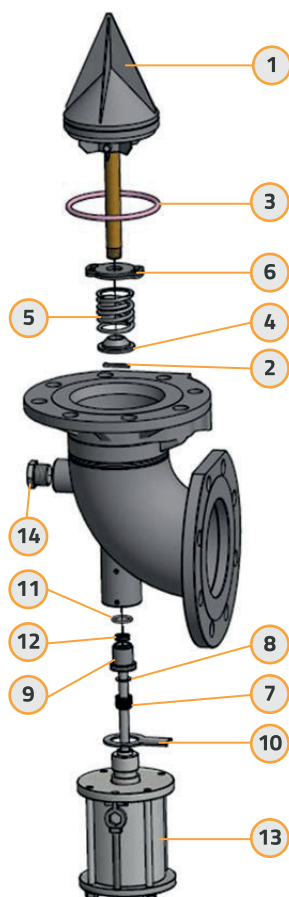

### KIT GUARNIZIONE PERNO

3	Guarnizione otturatore
1	Otturatore
2	Coppiglia

### KIT MOLLA

4	Disco
5	Molla
6	Molla a tazza
2	Coppiglia

### KIT GUARNIZIONI A CILINDRO

7	Baderna Chevron
8	Rondella
9	Cartuccia
10	Strumento per cartucce
11	O'Ring
12	Guarnizione di tenuta

### CILINDRO PNEUMATICO

13	Attuatore
14	Tappo



# VALVOLA DI FONDO CHEMFLOW 90°

## Caratteristiche

DN80

DN100



## RICAMBI

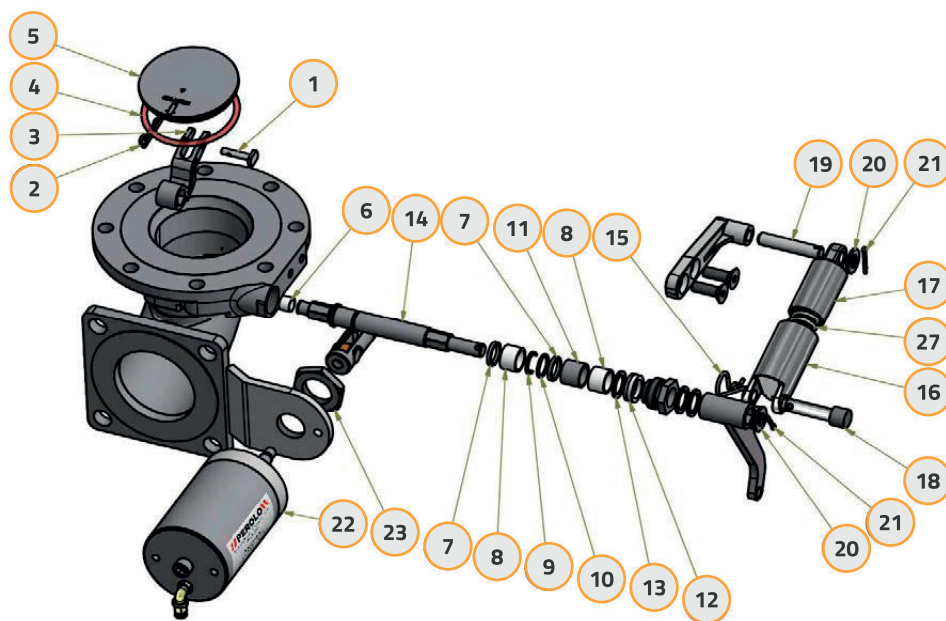

PEZZI DI RICAMBIO	
14	Perno
3	Forcella di sollevamento

KIT COMANDO	
6-8	Boccole a mandrino
7	Guarnizione Ekonol
9	Anello elastico
10	Anello di arresto
11	Distanziatore
12	Premistoppa
13	Anello di tenuta
20	Rondella
21	Perno

KIT OTTURATORE	
5	Otturatore piatto
4	O'ring
2	Perno
1	Mandrino a fungo

KIT MOLLE	
16	Custodia MK2 F
17	Custodia MK2 M
15	Forcella
20	Rondella
21	Perno
27	Molla



# VALVOLA A FARFALLA TANKFLY

## Caratteristiche

DN80

DN100



## ACCESSORI



FLANGIA CON  
FORO DISASSATO



FLANGIA CON  
FORO CENTRATO



GUARNIZIONE  
IMBUSTATA PTFE

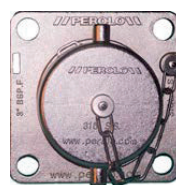

FLANGE

	DIMENSIONI	CONNESSIONE
QUADRE con/senza tappo	144x144	3" BSP
HALAR con/senza tappo	144x144	3" BSP 3" CAMLOCK
TONDE con/senza tappo	Ø165	2" BSP - 2" NPT

## RICAMBI

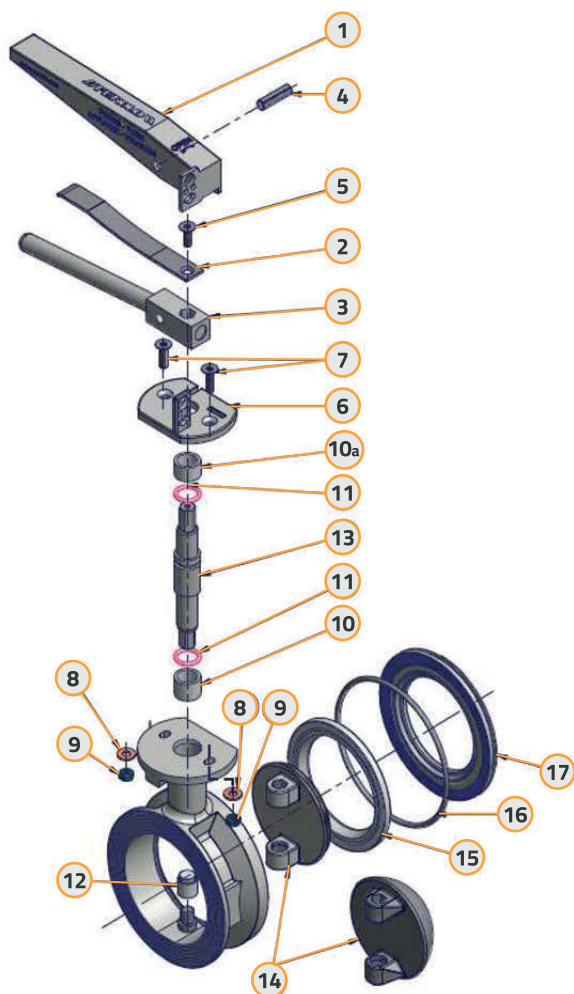

KIT MANIGLIA	
5	Vite M6-16
1	Maniglia
4	Coppiglia
2	Molla Piana
3	Leva per Maniglia

KIT LENTE	
15	Guarnizione Primaria PTFE
14	Lente
12	Boccola PTFE lente

KIT PIATTELLO	
17	Piattello INOX
16	OR

KIT PERNO	
5	Vite M6-16
4	Coppiglia per perno
7	Viti M6-20
8	Rondelle
9	Dadi
10	Boccola PTFE albero
10a	Boccola PTFE albero corta
11	O'Ring
12	Boccola PTFE lente
13	Perno



# VALVOLA A FARFALLA FK

## Caratteristiche

DN40

DN50

DN65

DN80

DN100

**Corpo:** PP-GR

**Disco:** PVC-U

**Stelo:** Acciaio INOX AISI 420  
A richiesta Acciaio INOX 316



## RICAMBI

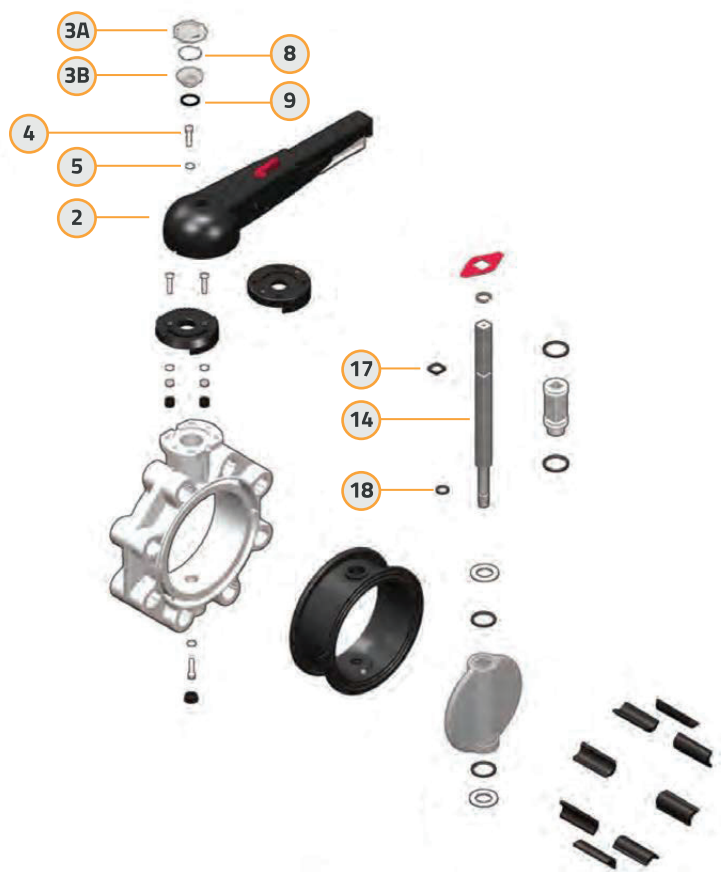

### 26 GUARNIZIONE PRIMARIA TENUE EPDM

2	Kit Maniglia
3A	
3B	
4	
5	
8	
9	

### 25 DISCO PVC-U

17	Kit tenute albero di ricambio
14	
18	

# VALVOLE A FARFALLA IN METALLO

## VALVOLA A FARFALLA CORPO IN GHISA

### Caratteristiche

DN80

DN100

DN125

DN150

DN 200



## VALVOLA A FARFALLA CORPO IN ALLUMINIO LENTE IN INOX

### Caratteristiche

DN100

DN125

DN150

DN200

# VALVOLA AKO

### Caratteristiche

DN150

DN200

## ACCESSORI



MANICOTTO DI RICAMBIO  
OMEPS LUNGO

MANICOTTO DI RICAMBIO  
OMEPS CORTO





# VALVOLA A SFERA AIRLINE

## Caratteristiche

DN32

DN40



## RICAMBI

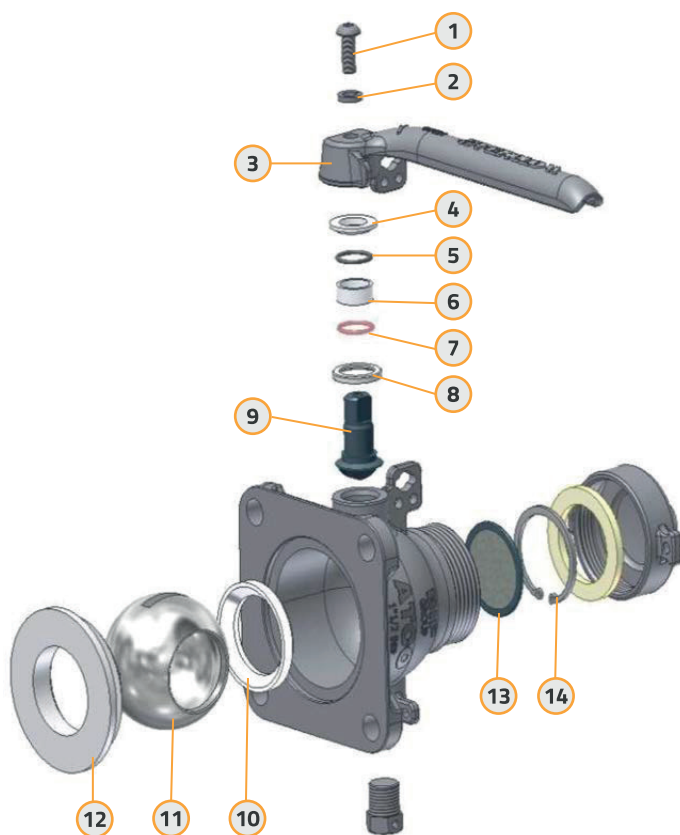

### KIT GUARNIZIONI SFERA

10	Guarnizione a sfera
11	Sfera
12	Piattello

### KIT MANIGLIA

1	Vite M6x16
2	Rondella W6
3	Maniglia
4	Rondella PTFE
5	O'Ring Viton
6	Boccola
7	O'Ring FEP/Silicone
8	Guarnizione perno
9	Perno

### KIT GUARNIZIONI PERNO

4	Rondella PTFE
5	O'Ring Viton
6	Boccola
7	O'Ring FEP/Silicone
8	Guarnizione perno

### KIT FILTRI

13	Filtro
14	Anello elastico



# VALVOLE A SFERA

## Caratteristiche

DN40

DN50

DN65

DN80

DN100



## RICAMBI



SFERA INOX



PERNO INOX



KIT GUARNIZIONI  
PREMISTOPPA PTFE



BOCCOLA PER LEVA DI  
APERTURA



FLANGIA FILETTATA  
CHIUSURA



GUARNIZIONI  
PRIMARIE SFERA

## ACCESSORI



CHIAVE UNIVERSALE  
INOX



MANIGLIA INOX



FLANGIA INOX  
OTTO FORI



GUARNIZIONE  
IMBUSTATA

## VALVOLA A SFERA CORPO PIATTO INOX

### Caratteristiche

DN40

DN50

DN65

DN80

DN100



## VALVOLA A SFERA CORPO PIATTO INOX INCAMICIATA

### Caratteristiche

DN80

DN100



## VALVOLA A SFERA F/F

### Caratteristiche

1/4"      1" 1/2

3/8"      2"

1/2"      2" 1/2

3/4"      3"

1"      4"

1" 1/4





# SEMIGUSCI

## METALLO



Inox

Ottone

Alluminio

## POLIPROPILENE



## OTTONE EN 14423



### Applicazioni

Assemblaggio di tubi in gomma per uso alimentare, farmaceutico e industriale

**Alluminio:** applicazioni in genere

**Ottone:** al fine di evitare il rischio di scintille

**Ottone secondo Normativa EN 14423:** in applicazioni con impiego di vapore

**Acciaio Inox:** nei cicli di lavaggio e nel settore alimentare e farmaceutico

**Polipropilene:** industria chimica

### Normative

EN 11420-3

DIN 2817

### Materiali

AISI316, Ottone, Alluminio, Polipropilene

### Pressione di esercizio

da -0,8 bar/-12 psi a 25 bar/362 psi

### Temperatura di utilizzo

da -20 °C / -4° F a + 65°C / 149° F

# BOCCOLE



### Materiali

AISI 304, AISI316, Alluminio

### Pressione di esercizio

25 bar / 362 psi



# ACCESSORI



TERMOMETRO



ETICHETTE ADESIVE  
300X300MM  
3-6-8-5-9

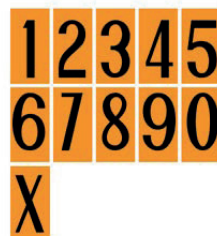

KIT NUMERI ADR



MANOMETRO D.63  
GLICERINA RADIALE  
ATTACCO DA 1/4"



RICAMBIO VALVOLA DI  
PARATIA NBR BIANCA



PIOLO INOX



CUNEO TIPO PERLINI



CUNEO TIPO PIACENZA



SCARICATORE  
DI CONDENSA

DN	DIM.
15	1/2"
20	3/4"
25	1"

Disponibile in
AISI 304
Acc. Carbonio

## ALTRI ACCESSORI

Etichette adesive 300x400mm arancione

Pannello porta etichette 300x300mm alluminio

Slitta porta numeri 300x400mm

Porta documenti in pvc

Guarnizioni culatta posteriore silos

Perni per cunei tipo perlini

Perni per cunei tipo piacenza



# TUBI IN GOMMA

## TUBO ISICHEM

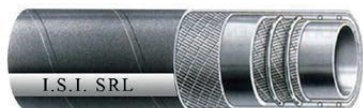

**DIAMETRI:** dal Ø 30 al Ø 100  
Mandata e aspirazione prodotti chimici secondo norma EN12115

## TUBO ISITANK

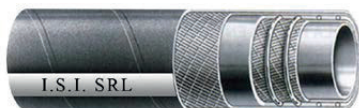

**DIAMETRI:** dal Ø 50 al Ø 80  
Mandata e aspirazione prodotti chimici aggressivi, indicato per camion cisterna

## TUBO ISIMILK



**DIAMETRI:** dal Ø 16 al Ø 100  
Aspirazione e mandata di latte, liquidi alimentari anche grassi, vino e acqua potabile

## TUBO ISIFOOD



**DIAMETRI:** dal Ø 50 al Ø 100  
Aspirazione e mandata liquidi alimentari, vino e acqua potabile

## TUBO ISIFUEL



**DIAMETRI:** dal Ø 30 al Ø 100  
Aspirazione e mandata oli minerali e carburanti

## TUBO ISIFLEXFUEL



**DIAMETRI:** dal Ø 60 al Ø 102  
Aspirazione e mandata oli minerali e carburanti

## TUBO ISIHOTAIR



**DIAMETRI:** dal Ø 38 al Ø 76  
Passaggio di aria calda, indicato per i compressori dei camioncisterna adibiti al trasporto di materiali sfusi

## TUBO ISISAND



**DIAMETRI:** Ø 102  
Mandata di prodotti abrasivi quali sabbia e cemento

## TUBO ISIDUST



**DIAMETRI:** Ø 102  
Trasporto pneumatico in mandata di farine, mangimi, cereali, granaglie, granuli di PE, PP e altri prodotti pulvirenti

## TUBO IDROCARBURI 10/20 BAR



**Tubo Long Length**  
**DIAMETRI:** dal Ø 6 al Ø 25  
Mandata di oli minerali, gasolio, carburanti e benzine ecologiche con contenuti aromatici fino al 50%

## TUBO ARIA - ACQUA 10/20 BAR



**Tubo Long Length**  
**DIAMETRI:** dal Ø 8 al Ø 25  
Mandata di acqua, aria compressa e fluidi inerti





# TUBI IN PVC

## TUBO TRANSFORT SUPERELASTIC



**DIAMETRI:** dal  $\varnothing$  40 al  $\varnothing$  200  
altri diametri disponibili su richiesta

Tubo per mandata a basse pressioni e aspirazione di liquidi, per impieghi gravosi su auto cisterne

## TUBO TRANSMETAL NT PF



**DIAMETRI:** dal  $\varnothing$  10 al  $\varnothing$  152  
altri diametri disponibili su richiesta

Tubo per mandata e aspirazioni di liquidi alimentari con tenore alcolico fino a 50°C (simulanti a,b,c,d1)

# TUBI TRECCIATI INOX

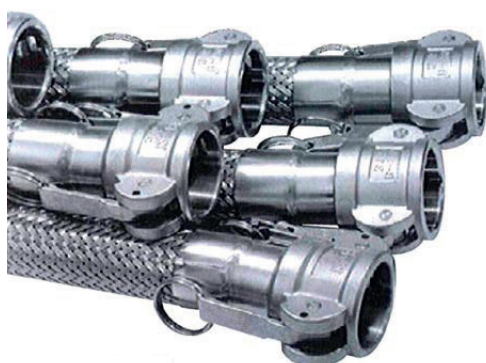

**OTTIMA RESISTENZA AL CALORE**  
da -270°C a + 700°C

**DIAMETRI INTERNI DISPONIBILI**  
Dal  $\varnothing$  6 al  $\varnothing$  300

**RIVESTIMENTI DISPONIBILI**  
Calza fibra di vetro siliconata  
Calza in fibra di vetro  
Calza in tessuto protettiva



TRECCIA SINGOLA



TRECCIA DOPPIA



# TUBI COMPOSITI

## APPLICAZIONI

Vagoni ferroviari

Plant transfer

Operazioni marittime pesanti, carico e scarico di navi e chiatte



## CONFIGURAZIONE STRUTTURA materiali disponibili

### SPIRALE INTERNA

Acciaio zincato

Alluminio

AISI316

Acciaio rivestito polipropilene

### RIVESTIMENTO INTERNO

Polipropilene

PTFE

FEP

ECTFE (Hostaflon)

### RIVESTIMENTO ESTERNO

PVC rivestito poliestere

Polipropilene rivestito PVC

### SPIRALE ESTERNA

Acciaio zincato

Alluminio

AISI 316

## RACCORDI FLANGIATI



FLANGIA FISSA



FLANGIA SCORREVOLE

### MATERIALI DISPONIBILI

Acciaio Carbonio

Acciaio Inox

Ottone

Polipropilene

## RACCORDI FILETTATI



DADO GIREVOLE FEMMINA

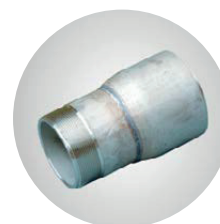

NIPPO FILETTO MASCHIO

### MATERIALI DISPONIBILI

Acciaio Carbonio

Acciaio Inox

Alluminio

Ottone

Polipropilene



# SERVIZI CUSTOM



## IDENTIFICAZIONE VALVOLE TAG

Codici EAN, Tag e Serial Number personalizzati su richiesta del cliente per una corretta tracciabilità del prodotto



## IMBALLAGGI PARTICOLARI CERTIFICATI

Imballaggi industriali su misura per totale sicurezza delle merci e certificati nel rispetto delle normative internazionali



## CONSEGNA PERSONALIZZATA

Gestione della spedizione per un trasporto organizzato secondo la specifica richiesta del cliente



## TRACCIABILITÀ PRODOTTO

Personalizzazione del codice-prodotto su richiesta del cliente per la gestione della tracciabilità e delle scorte



## ASSISTENZA TECNICA

Personale tecnico specializzato sempre a disposizione del cliente



HEXAGON  
WORLD

# LAVORAZIONI CUSTOM

## FRESATURA

### ▪ Macchinari

CNC a 3 e 5 assi e software di programmazione CAD CAM



## TORNITURA

### ▪ Macchinari Torno CNC

## AUTOMAZIONE VALVOLE

Pneumatica o elettrica con attuatori standard / a norma ATEX / a tenuta stagna IP/NEMA fino a sistemi integrati gestiti da segnali GPS.



## INCOLLAGGIO POLIFUSIONE

---

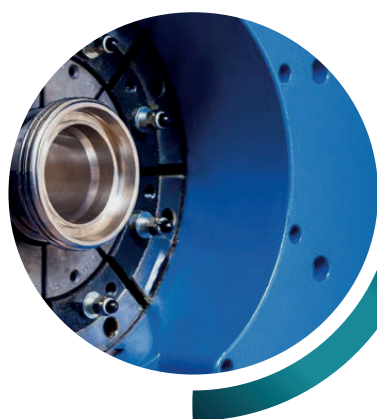

## RACCORDERIA TUBI

---

- 01** | Vasta scelta di tubi in gomma o in PVC e raccordi per ogni esigenza
- 02** | Raccordatura tramite collari, semigusci o boccole pressate
- 03** | Certificato di collaudo su richiesta

## ASSEMBLAGGI SPECIALI

---

Tecnologie specifiche per ogni lavorazione: polifusione, saldatura, piegatura e foratura. Preassemblati, mini-skid o parti di impianto su disegno e/o nuovo progetto elaborato con cliente.

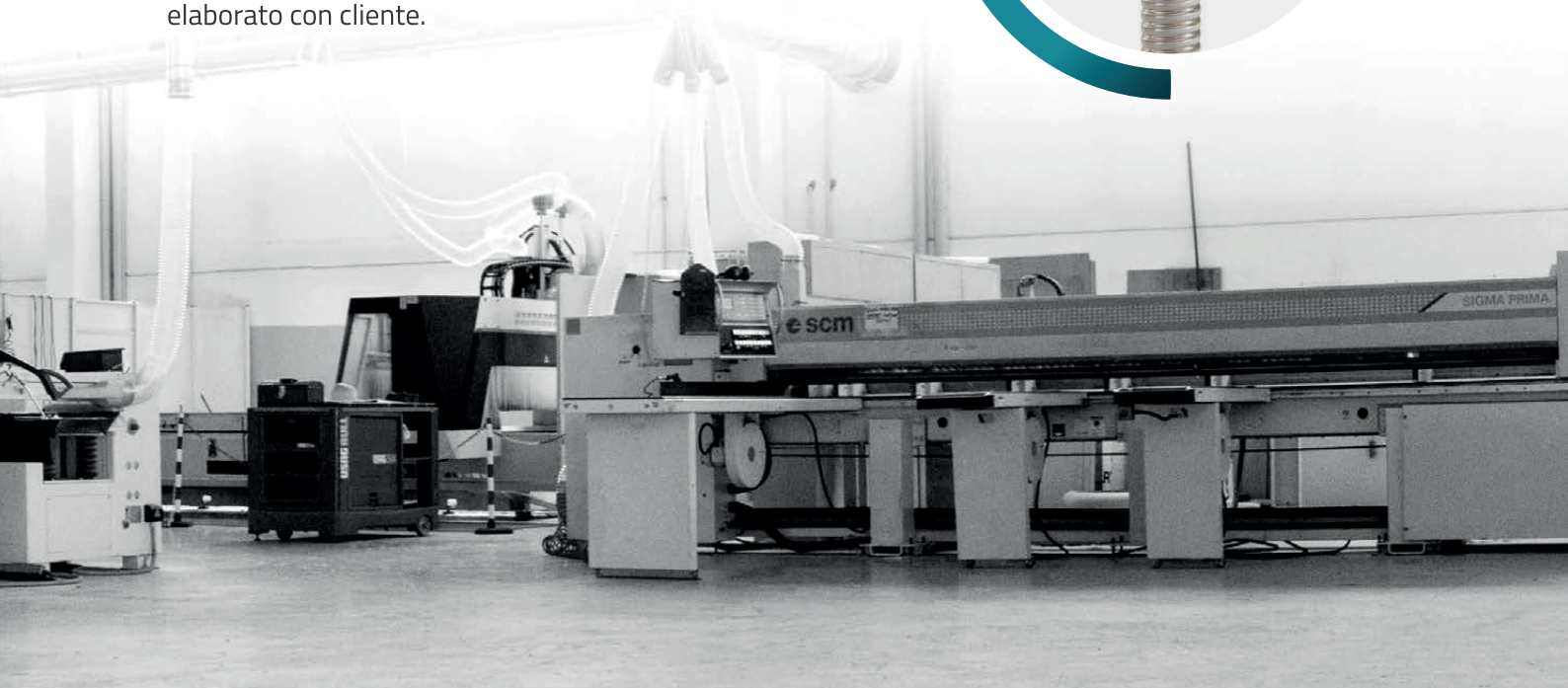



# **HEXAGON** **WORLD**

Via Nicolò Pittari, S/N  
(Contrada Buttaceto, Zona Ind.)  
95121 - Catania  
**Tel.** (+39) 095 591248

**Ufficio Amministrativo**  
amministrazione@hexagonworldsrl.com

P.Iva: 05323330877  
SDI: M5UXCR1

**[www.hexagonworldsrl.com](http://www.hexagonworldsrl.com)**